

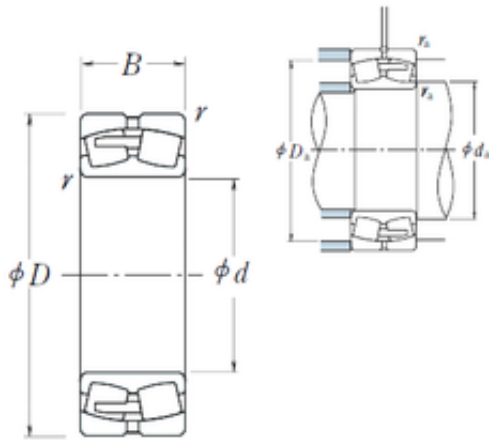

BEARING USA CORP.

23996CAE4 NSK Spherical Roller Bearing



Bearing No. 23996CAE4

Size	480x650x128 mm
Bore Diameter	480 mm
Outer Diameter	650 mm
Width	128 mm
d	480 mm
D	650 mm
B	128 mm
C	128 mm
r min.	5 mm
da min.	502 mm
Da min	602 mm
Da max.	628 mm
ra max.	4 mm
Weight	121 Kg
Basic dynamic load rating (C)	2580 kN
Basic static load rating (C0)	5850 kN
(Grease) Lubrication Speed	400 r/min
(Oil) Lubrication Speed	500 r/min
Calculation factor (e)	0,18
Calculation factor (Y0)	3,7
Calculation factor (Y2)	5,7

23996CAE4 Bearing 2D drawings and 3D CAD models