

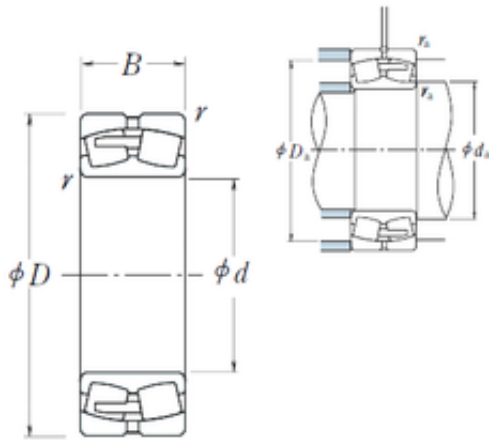

BEARING USA CORP.

230/850CAE4 NSK Spherical Roller Bearing



Bearing No. 230/850CAE4

Size	850x1220x272 mm
Bore Diameter	850 mm
Outer Diameter	1220 mm
Width	272 mm
d	850 mm
D	1220 mm
B	272 mm
C	272 mm
r min.	7,5 mm
da min.	886 mm
Da min	1109 mm
Da max.	1184 mm
ra max.	6 mm
Weight	1020 Kg
Basic dynamic load rating (C)	9300 kN
Basic static load rating (C0)	21400 kN
(Grease) Lubrication Speed	180 r/min
(Oil) Lubrication Speed	220 r/min
Calculation factor (e)	0,21
Calculation factor (Y0)	3,1
Calculation factor (Y2)	4,8

230/850CAE4 Bearing 2D drawings and 3D CAD models