

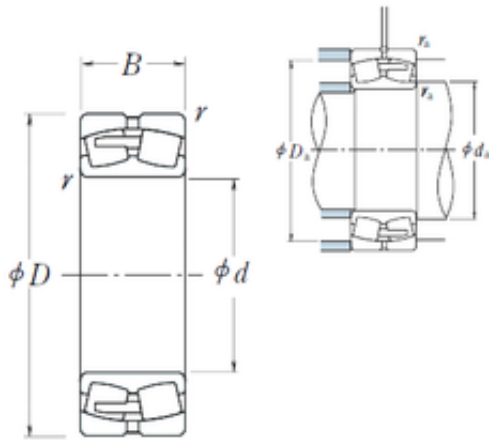

BEARING USA CORP.

239/1000CAE4 NSK Spherical Roller Bearing



Bearing No. 239/1000CAE4

Size	1000x1320x236 mm
Bore Diameter	1000 mm
Outer Diameter	1320 mm
Width	236 mm
d	1000 mm
D	1320 mm
B	236 mm
C	236 mm
r min.	7,5 mm
da min.	1036 mm
Da min	1229 mm
Da max.	1284 mm
ra max.	6 mm
Weight	881 Kg
Basic dynamic load rating (C)	8200 kN
Basic static load rating (C0)	21700 kN
(Grease) Lubrication Speed	150 r/min
(Oil) Lubrication Speed	190 r/min
Calculation factor (e)	0,16
Calculation factor (Y0)	4,2
Calculation factor (Y2)	6,4

239/1000CAE4 Bearing 2D drawings and 3D CAD models