

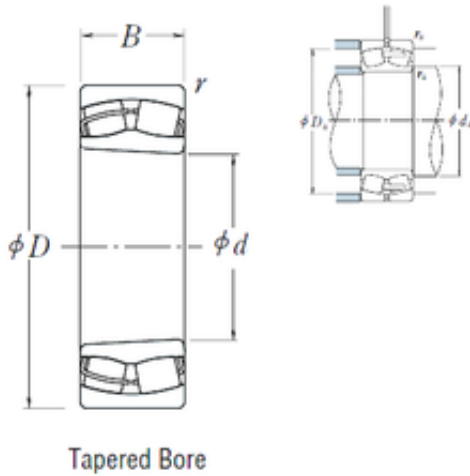

# BEARING USA CORP.



## 24028CK30E4 NSK Spherical Roller Bearing

Bearing No. 24028CK30E4

Size	140x210x69 mm
Bore Diameter	140 mm
Outer Diameter	210 mm
Width	69 mm
d	140 mm
D	210 mm
B	69 mm
C	69 mm
r min.	2 mm
da min.	150 mm
da max	154 mm
Da min	186 mm
Da max.	200 mm
ra max.	2 mm
Weight	8,37 Kg
Basic dynamic load rating (C)	525 kN
Basic static load rating (C0)	945 kN
(Grease) Lubrication Speed	1300 r/min
(Oil) Lubrication Speed	1700 r/min
Calculation factor (e)	0,29
Calculation factor (Y0)	2,2
Calculation factor (Y2)	3,4
Category	Bearings
Inventory	0.0
Manufacturer Name	NSK
Minimum Buy Quantity	N/A

24028CK30E4 Bearing 2D drawings and 3D CAD models



## BEARING USA CORP.

Weight / Kilogram	8.2
Product Group	B04311
Y3	2.3
hidYobi	24028CK30E4
LangID	1
Y1	2.2
D_	210
Y2	3.4
Macha rpm	0
B_	69
da min	150
hidTable	ecat_NSSPHR
Oil rpm	1700
Y0	2.2
mass	8.37
GRS rpm	1300
ra	2
TSR rpm	2200
C0	945
DE_	192.344
X0	1
Prod_Type3	SRB_CTB_TB
X1	1
X2	0.67
SIR	27.5
e	0.29
DA_	17.5
bomp	24028CK30E4
Z_	26
ALP2	5
ALP1	11
ALP3	0



## BEARING USA CORP.

D_a max	200
D_a min	186
yobi	24028CK30E4
ALPHA_	0.193
SDM_	175.171
r	2
KBRG	2322
SBRG	40
DI_	157.997